

BATTERY HOLDERS

12V or 24V Chassis Mount or Din Rail Mount



For Maintenance -free lead-acid batteries
Output: 12; 24 Vdc
Protection: Fuse
Connection with screws
Short circuit Protection
Wall Mount with screws / Din Rail

Feature:

These metal battery holders are made from aluminum and designed to provide an easy solution for mounting batteries onto a din rail or just chassis mounting. They are designed to fit standard maintenance free lead acid batteries with standard sizes of 1.2AH , 3.2AH , 7.2AH , 12AH Each battery holder is fitted with a fuse to protect the battery , connection is through a screw terminal connection on the frame.

Battery Holder / : 12 Vdc and 24 Vdc (2 x 12 Vdc)

Feature

Battery Holder	12 Vdc		24 Vdc (2 x 12 Vdc)			
Chassis Mount Version	BAT-HOLDER-12V-3.2AH-CM	BAT-HOLDER-12V-7.2AH-CM	BAT-HOLDER-24V-1.2AH-CM	BAT-HOLDER-24V-3.2AH-CM	BAT-HOLDER-24V-7.2AH-CM	BAT-HOLDER-24V-12AH-CM
DIN Rail Mount Version	BAT-HOLDER-12V-3.2AH-DIN	BAT-HOLDER-12V-7.2AH-DIN	BAT-HOLDER-24V-1.2AH-DIN	BAT-HOLDER-24V-3.2AH-DIN	BAT-HOLDER-24V-7.2AH-DIN	NOT AVAILABLE
Short-circuit protection	Yes					
Protection Fuse	25 A					
Ambient Temperature (operation)	-25 ÷ +50 °C (depend on battery)					
Ambient Temperature (Storage)	-20 ÷ +50 °C					

Generic data

Dimension (w-h-d) mm	105x102x87.5	105x102x120.5	170x102x80	170x102x87.5	170x102x120.5	236x102x120.5
Weight Standard	190g approx	200g approx	280g approx	280g approx	290g approx	390g approx
Weight DIN RAIL	210g approx	220g approx	300g approx	300g approx	310g approx	
Protection class	IP20					
Chassis Mount Versions	For chassis mount using M4 screws					
DIN Rail Mount Versions	For mounting on a 35mm din rail					

BATTERY HOLDERS

12V or 24V Chassis Mount or Din Rail Mount

MOUNTING HOLES IN THE MOUNTING PLATE OF SINGLE BATTERY 12V

3D Front View

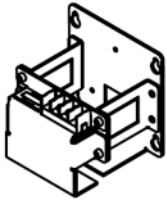

DIMENSION

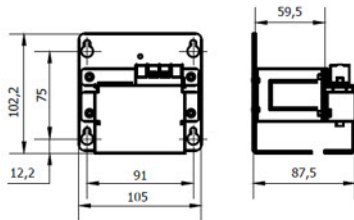

BAT-HOLDER-12V-3.2AH-CM

3D Front View

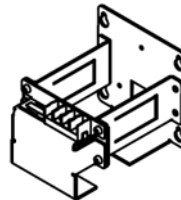

DIMENSION

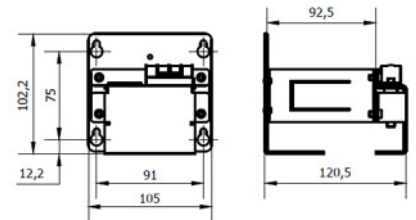

BAT-HOLDER-12V-7.2AH-CM

MOUNTING HOLES IN THE MOUNTING PLATE OF DOUBLE BATTERY 24V FROM 1.2Ah TO 12Ah

3D Front View

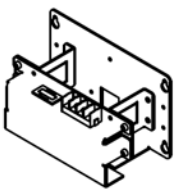

DIMENSION

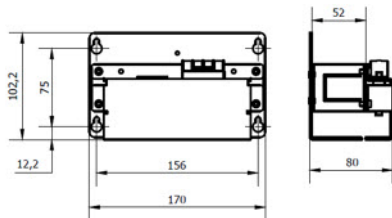

BAT-HOLDER-24V-1.2AH-CM

3D Front View

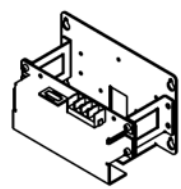

DIMENSION

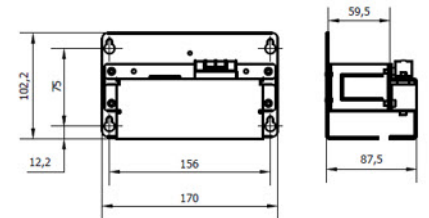

BAT-HOLDER-24V-3.2AH-CM

3D Front View

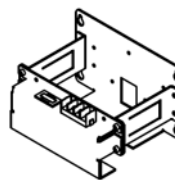

DIMENSION

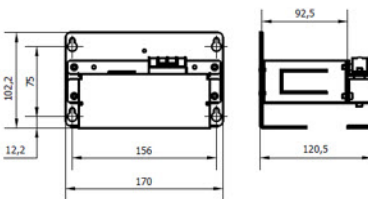

BAT-HOLDER-24V-7.2AH-CM

3D Front View

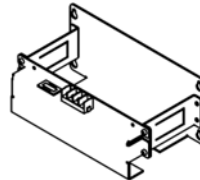

DIMENSION

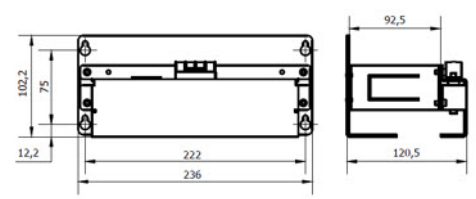

BAT-HOLDER-24V-12AH-CM

REAR MOUNTING VIEW OF THE MOUNTING PLATE SINGLE AND DOUBLE BATTERY HOLDER DIN VERSION:

Single Battery 12V
3D Rear View DIN Version

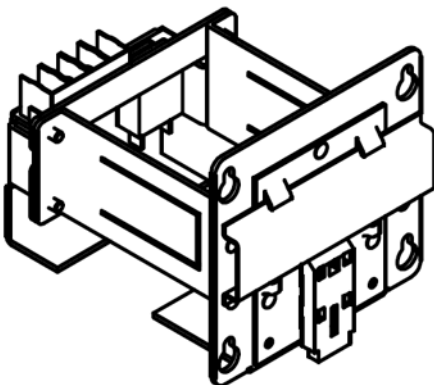

Double Battery 24V
3D Rear View DIN Version

